



US

Operator's manual

Please read the operator's manual carefully and make sure you understand the instructions before using the machine.

FR

Manuel d'utilisation

Lire attentivement et bien assimiler le manuel d'utilisation avant d'utiliser la machine.

ES

Manual de instrucciones

Lea detenidamente el manual de instrucciones y asegúrese de entender su contenido antes de utilizar la máquina.

PG 400SF
PG 280 SF

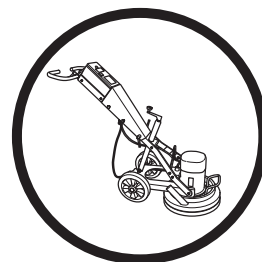

US FR ES

KEY TO SYMBOLS

Symbols on the machine:

WARNING! The machine can be a dangerous tool if used incorrectly or carelessly, which can cause serious or fatal injury to the operator or others.



Please read the operator's manual carefully and make sure you understand the instructions before using the machine.



Always wear:

- Approved protective helmet
- Approved hearing protection
- Protective goggles or a visor
- Breathing mask



Wear boots with steel toe-caps and non-slip sole.

Always wear protective gloves.

WARNING!

Dust forms when grinding, which can cause injuries if inhaled. Use an approved breathing mask. Always provide for good ventilation.



Environmental marking. Symbols on the product or its packaging indicate that this product cannot be handled as domestic waste.



By ensuring that this product is taken care of correctly, you can help to counteract the potential negative impact on the environment and people that can otherwise result through the incorrect waste management of this product.



For more detailed information about recycling this product, contact your municipality, your domestic waste service or the shop from where you purchased the product.

Symbols in the operator's manual:

Inspection and/or maintenance should be carried out with the motor switched off and the plug disconnected.

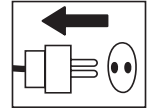

Always wear approved protective gloves.

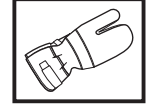

Regular cleaning is required.

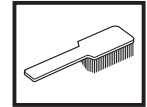

Visual check.



Protective goggles or a visor must be worn.



CONTENTS

Contents

KEY TO SYMBOLS

Symbols on the machine:	2
Symbols in the operator's manual:	2

CONTENTS

Contents	3
----------------	---

WHAT IS WHAT?

What is what on the grinder?	4
------------------------------------	---

SAFETY INSTRUCTIONS

Before using a new grinder	5
Personal protective equipment	5
General safety precautions	6

ASSEMBLY

Changing the diamonds	8
Connect the vacuum cleaner	8
Transport	8

GRINDING GUIDE

Diamonds	9
Determining the hardness of concrete	9
Diamond selection	10

STARTING AND STOPPING

Before starting	13
Starting	13
Stopping	13

MAINTENANCE

Faults and trouble shooting	14
Maintenance	14
Service	14

TECHNICAL DATA

Technical data	15
----------------------	----

US WARRANTY STATEMENT

WARRANTY POLICY	16
EQUIPMENT	16

WHAT IS WHAT?

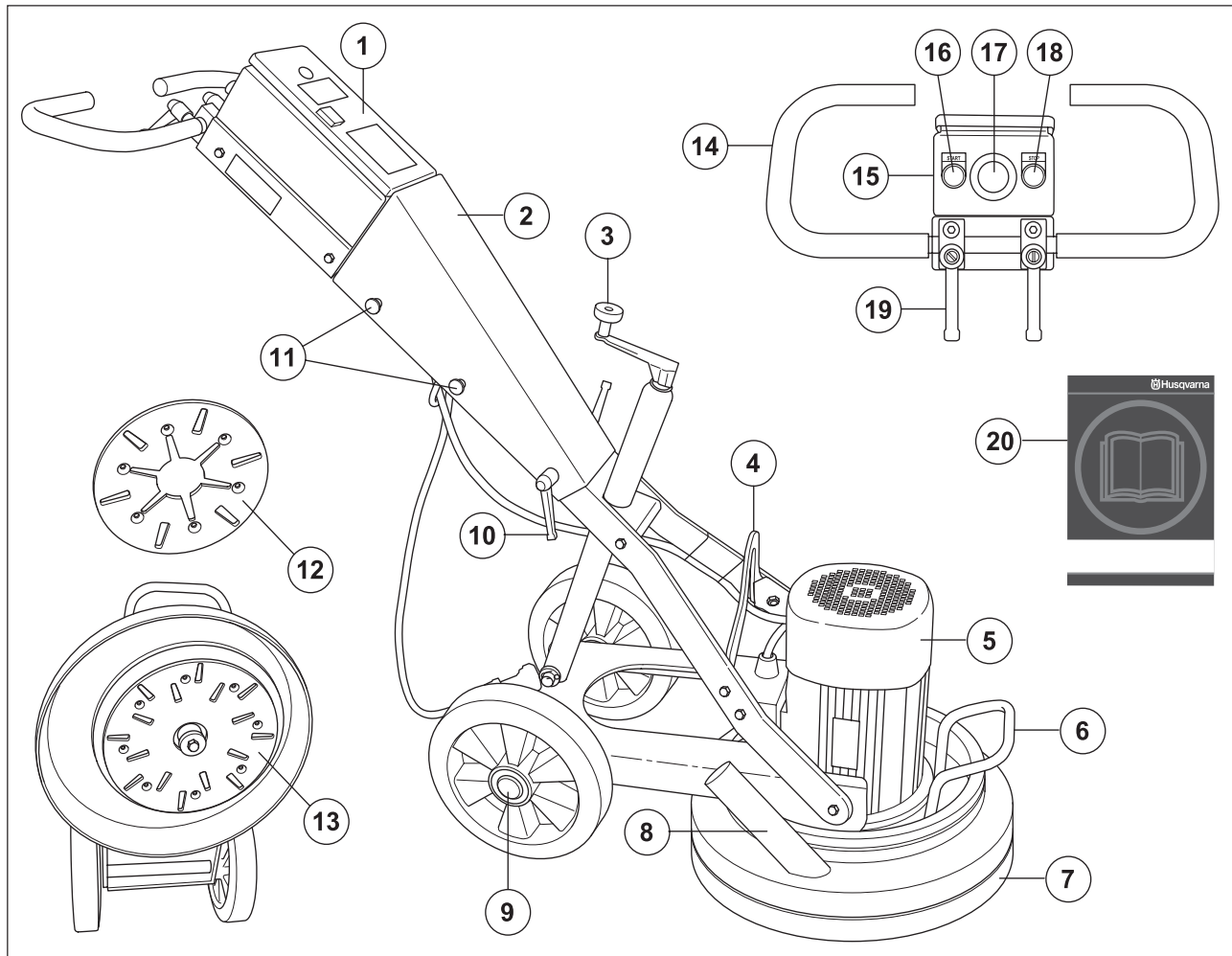

What is what on the grinder?

- | | |
|---|--|
| 1 Electric box | 11 Screws, cover |
| 2 Cover | 12 Grinding unit - PG 280 SF |
| 3 Crank for adjusting grinding pressure | 13 Grinding unit - PG 400 SF |
| 4 Lifting eye | 14 Handle / handlebar |
| 5 Engine | 15 Control Panel |
| 6 Lifting handle | 16 Start button |
| 7 Skirt | 17 Emergency stop |
| 8 Connection for vacuum cleaner | 18 Stop button |
| 9 Wheel set | 19 Locking knob for handlebar adjustment |
| 10 Locking knob cover | 20 Operator's manual |

SAFETY INSTRUCTIONS

Before using a new grinder

- Please read the operator's manual carefully and make sure you understand the instructions before using the machine.
- Grinders PG 400 SF and PG 280 SF are designed for surface removal of glue/adhesive residues, putty and the like from concrete floors and grinding and flattening out concrete floors. SF stands for single disc, fixed speed (single disc, fixed speed).
- The machine can cause serious personal injury. Read the safety instructions carefully. Learn how to use the machine.
- Only staff that have received the necessary education, both practically and theoretically concerning their usage should operate the machinery.

Always use common sense

It is not possible to cover every conceivable situation you can face. Always exercise care and use your common sense. Avoid all situations which you consider to be beyond your capability. If you still feel uncertain about operating procedures after reading these instructions, you should consult an expert before continuing.

Do not hesitate to contact your dealer if you have any more questions about the use of the machine. We will willingly be of service and provide you with advice as well as help you to use your machine both efficiently and safely.

Let your Husqvarna dealer regularly check the machine and make essential adjustments and repairs.

All information and all data in the Operator's Manual were applicable at the time the Operator's Manual was sent to print.



WARNING! Under no circumstances may the design of the machine be modified without the permission of the manufacturer. Always use genuine accessories. Non-authorized modifications and/or accessories can result in serious personal injury or the death of the operator or others.



WARNING! Use of products which cut, grind, drill, sand or shape material can generate dust and vapors which may contain harmful chemicals. Know the nature of the material being worked on and wear appropriate dust mask or respirator protection.



WARNING! Some dust created by power sanding, sawing, grinding, drilling, and other construction activities contains chemicals known (to the State of California) to cause cancer, birth defects or other reproductive harm. Some examples of these chemicals are:

Lead from lead-based paints.

Crystalline silica from bricks, cement and other masonry products.

Arsenic and chromium from chemically treated lumber.

Your risk from these exposures varies, depending on how often you do this type of work. To reduce your exposure to these chemicals: work in a well ventilated area, and work with approved safety equipment, such as those dust masks that are specially designed to filter out microscopic material.

Personal protective equipment



WARNING! You must use approved personal protective equipment whenever you use the machine. Personal protective equipment cannot eliminate the risk of injury but it will reduce the degree of injury if an accident does happen. Ask your dealer for help in choosing the right equipment.

- Protective helmet
- Hearing protection
- Protective goggles or a visor



- Breathing mask

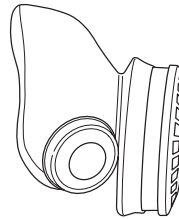

- Heavy-duty, firm grip gloves.

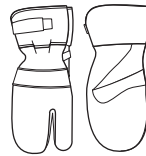

- Tight-fitting, heavy-duty and comfortable clothing that permits full freedom of movement.



- Boots with steel toe-caps and non-slip sole



- Always have a first aid kit nearby.



SAFETY INSTRUCTIONS

General safety precautions



WARNING! This section describes basic safety directions for using the machine. This information is never a substitute for professional skills and experience. If you get into a situation where you feel unsafe, stop and seek expert advice. Contact your dealer, service agent or an experienced power cutter user. Do not attempt any task that you feel unsure of!

- Do not use the machine without first reading and understanding the contents of this Operator's Manual.

Work area safety

- Do not use the machine in bad weather, such as dense fog, rain, strong wind, intense cold, etc.
- Keep work area clean and well lit. Cluttered or dark areas invite accidents.
- The machine should not be used in areas where potential for fire or explosions exist.

Electrical safety



WARNING! There is always a risk of shocks from electrically powered machines. Avoid unfavourable weather conditions and body contact with lightning conductors and metal objects. Always follow the instructions in the Operator's manual to avoid damage.

- Never drag the machine by means of the cord and never pull out the plug by pulling the cord.
- Keep all cables away of water, oil and sharp edges. Make sure the cable is not pinched in doors, fences or the like. Otherwise it can cause the object to become live.
- Check that the cables are intact and in good condition. Use cable intended for outdoor use.
- Never use the machine if any cable is damaged, but hand it in to an authorized service workshop for repair.
- The machine should be connected to an earthed outlet socket.
- Check that the mains voltage corresponds with that stated on the rating plate on the machine.
- Be on your guard for electrical shocks. Avoid having body contact with lightning-conductors/metal in the ground.
- Do not use an extension cord while it is rolled up to avoid overheating.
- Ensure the cord is behind you when you start to use the machine so that the cord will not be damaged.

Personal safety



WARNING! Overexposure to vibration can lead to circulatory damage or nerve damage in people who have impaired circulation. Contact your doctor if you experience symptoms of overexposure to vibration. Such symptoms include numbness, loss of feeling, tingling, pricking, pain, loss of strength, changes in skin colour or condition. These symptoms normally appear in the fingers, hands or wrists. These symptoms may be increased in cold temperatures.

- Wear personal protective equipment. See instructions under the heading Personal protective equipment.
- Never use the machine if you are tired, if you have drunk alcohol, or if you are taking medication that could affect your vision, your judgement or your co-ordination.
- Never allow anyone else to use the machine without first ensuring that they have understood the contents of the operator's manual.
- All operators shall be trained in the use of the machine. The owner is responsible for ensuring that the operators receive training.
- People and animals can distract you causing you to lose control of the machine. For this reason, always remain concentrated and focused on the task.
- Be careful as clothing, long hair, and jewellery can get caught in moving parts.
- Never leave the machine unsupervised with the engine running.
- Make sure that there is always another person close at hand when you use the machines, so that you can call for help if an accident should occur.
- Always ensure you have a safe and stable working position.

SAFETY INSTRUCTIONS

Use and care

- Only use the machine for the purpose it was intended for.
- Keep all parts in good working order and ensure that all fixtures are properly tightened.
- Never use a machine that is faulty. Carry out the checks, maintenance and service instructions described in this manual. Some maintenance and service measures must be carried out by trained and qualified specialists. See instructions under the heading Maintenance.
- Do not modify safety equipment. Check regularly that they function as they should. The machine must not be run with defective or disassembled safety equipment.
- Never use a machine that has been modified in any way from its original specification.
- Machinery should only be started when grinding heads are resting on the ground unless carrying out a testing procedure as outlined in this manual.
- The machine should not be started without the rubber dust skirt attached. It is essential a good seal between machine and floor be established for safety, especially when operating in dry grinding applications.
- During grinding, the machine must be connected to a vacuum cleaner to sucking off the dust.
- When changing the grinding discs ensure power supply to the unit is OFF by engaging the Emergency Stop button and the power-plug disconnected.
- After each grinding/polishing operation always remove the diamond tools.
- Make sure that the rubber skirt is intact and clean and that it seals tightly against the floor. Damaged rubber skirt should always be replaced.
- When removing glue, asphalt, paint etc. always raise the machine from the surface after use to prevent it from sticking to the floor due to the heat. Make sure the grinding head has stopped rotating before raising the machine.
- Diamond tools may be very hot after use. Leave machine to cool off before removing the diamond segments. Use protective gloves.
- Always use the machine mounted lifting eye when lifting.
- Always carry the machine by the carrying handle and the handle.

Transport and storage

- The machine should always be transported under cover limiting the exposed to natural elements – in particular rain and snow.
- Store the equipment in a lockable area so that it is out of reach of children and unauthorised persons.
- The machine should always be stored in a dry place when not in use.

ASSEMBLY

Changing the diamonds



Shut down the machine and disconnect the power plug.
Have a set of gloves ready, as diamond tools can get very hot.

- 1 Crank up the handlebar to the highest position.

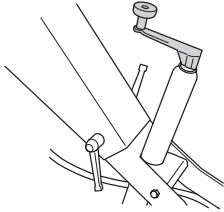

- 2 Pull back on handle to lift grinding head off the ground.
- 3 Lay machine back on the ground.

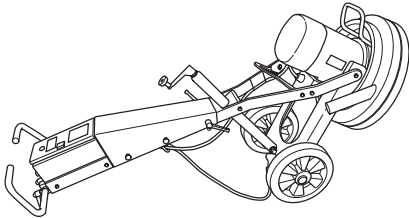

- 4 Put on gloves.
- 5 Use a rubber hammer/mallet to remove the diamond segments.

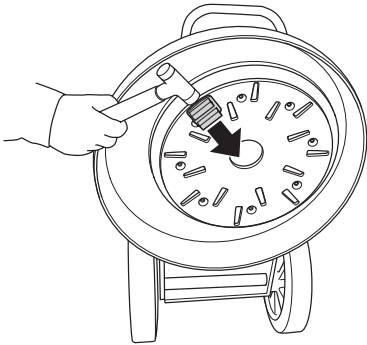

- 6 Affix new diamond segments on the grinding disc.

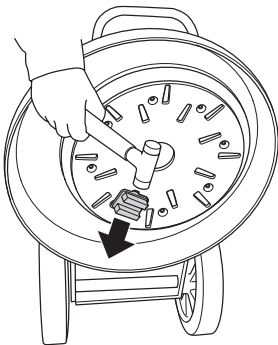

- 7 Once new diamond segments have been attached, reverse procedure to lower machine to ground.

Connect the vacuum cleaner

Connect the vacuum cleaner to the machine.

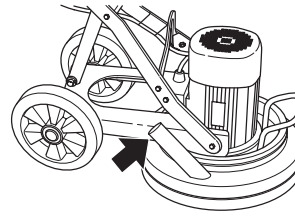

It is highly recommended to use the Husqvarna DC 3300 dust extraction system for complete dust control.

Make sure that the filters in the vacuum cleaner are intact and clean. Pay attention to dust during operation.

Transport

The machine can be folded to minimize space needed for transport.

- 8 Loosen the screws and the lock handle that hold the cover in place.

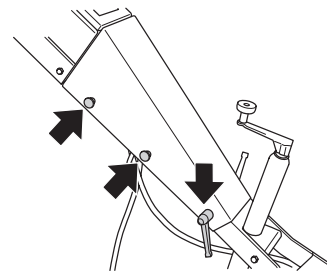

- 1 Place the crank with the handle pointing straight upwards.

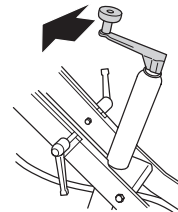

- 2 Remove the cover.
- 3 Carefully fold the machine forward.

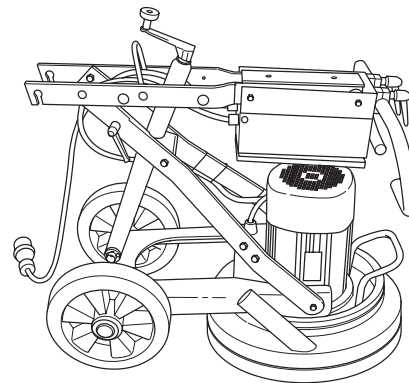

- 4 The cover can be attached to the side of the machine.

GRINDING GUIDE

Diamonds

Background

Diamond abrasives usually consist of 2 components:

- 1 Diamond powder (also known as diamond crystals or grit). By changing the size of the diamond powder or grit, we can change how coarse or fine the scratches will be that are left behind from the grinding process.
- 2 A binding agent (metal or resin). Diamond powder is mixed and suspended in either a metal or resin binding agent. When suspended in a metal binding agent, the finished product is referred to as a Metal Bond or Sintered diamond segment. When suspended in a resin binding agent, the finished product is referred to as a Resin Bond diamond segment or pad. By changing the hardness of the binding agent, we can change how fast or slow the diamond abrasive will wear.

General Principles

The following are general rules regarding diamond segments in grinding applications. As with all general rules there are exceptions or cases when it is not the case.

Diamond grit size

Changing the size of the diamond grit to a smaller particle/grit size will effect the performance of the diamond tool in the following ways:

- Create a finer scratch pattern.
- Increase life of diamond tool.

The opposite will occur when changing to a larger particle/grit size.

Binding agent

Increasing hardness of bond will:

- Create a finer scratch pattern.
- Increase life of diamond tool.
- Decrease production rate.

The opposite will occur when making the metal or resin bond softer.

Number of diamond segments/pads under the machine

Increasing the number of segments under the machine will:

- Reduce pressure on each individual diamond segment - reduce wear rate on diamond segments.
- Reduce load on the machine and cause the grinder to draw less current.
- Create a smoother scratch pattern (particularly on soft floors).

The opposite will occur when decreasing the number of segments under the machine.

Summary of diamond principles

Diamond segments need to wear in order to achieve productivity. Diamond segment wear can be influenced by the following factors:

- Pressure.
- Hardness of bond.
- Diamond grit size.
- Number of segments under the machine.
- Adding an additional abrasive (e.g. sand, silicone carbide) on the floor will increase wear.

Generally speaking, the faster a diamond segment wears, the faster the productivity will be. By varying the above factors, changes can also be made to effect the following:

- Scratch pattern.
- Current draw of machine.
- Flatness of floor (see next section).
- Ease of operation.

Determining the hardness of concrete

All concretes are measured by their compressive strength and depending on which part of the world you are from, different compressive strength indices (e.g. P_{Si} & MPa) are used. Generally speaking, the higher the compressive strength rating, the harder the concrete and therefore, the harder it will be to grind.

However, other factors beside compressive strength ratings determine how hard the floor will be, and therefore, the correct diamond selection. Since grinding normally only deals with the surface of the concrete (top 5mm or 1/4 inch), often the way the concrete floor has been finished or the condition of the surface will have a greater bearing on what type of diamond to select, rather than the compressive strength rating of the concrete.

Surface factors to consider when making a diamond selection

Generally speaking, if a concrete surface is very smooth (i.e. Most likely it has been heavily trowelled/helicoptered), the concrete will behave as if it has a high compressive strength and therefore, require a soft bond segment.

Accordingly, if a concrete surface is coarse/aggressive (e.g. rain-damaged, shot blasted, scarified, exposed aggregate e.t.c.), the concrete will behave as if it has a low compressive strength and therefore, require a hard bond segment.

Surface coatings/contaminants (e.g. Epoxy coatings, ceramic tile adhesives, levelling compounds/screeds) will often have a larger bearing on what diamond to select, than will the compressive strength of the concrete.

As a general rule, when grinding a concrete slab for the first time and you are unsure about its hardness, always begin with harder bond diamonds under the machine. This will ensure the least amount of wear on the diamond segments. If a hard diamond segment is not suited to the application, all it has cost is a little amount of time without wearing out the diamonds.

If performed the other way around (i.e. a soft segment is used to begin with) and the concrete is soft or possesses an abrasive surface or surface contaminant, it is quite possible to wear-out a considerable amount of diamond in very short period of time.

GRINDING GUIDE

Diamond selection

The way diamond segments are set-up on the grinding unit will greatly influence the performance of the machine, the productivity levels and also the finished floor quality.

There are a number of different diamond configurations that can be achieved on both the PG 400 SF and PG 280 SF.

Metal bond diamonds

Full set - inner and outer row

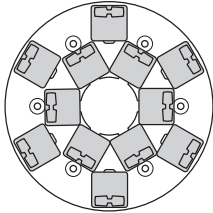

PG 280

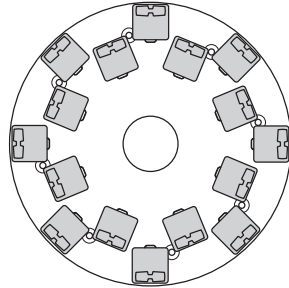

PG 400

Full set - outer row

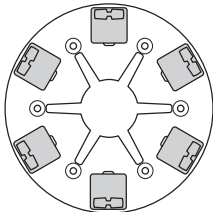

PG 280

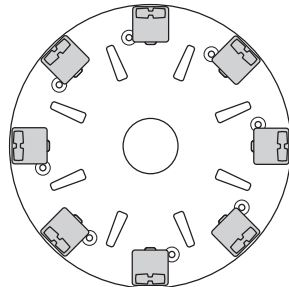

PG 400

Half set - inner and outer row

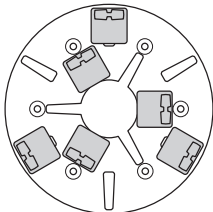

PG 280

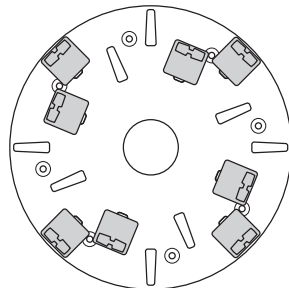

PG 400

Half set - outer row

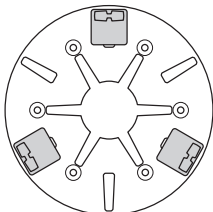

PG 280

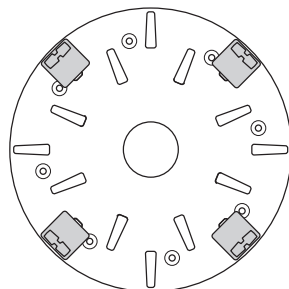

PG 400

GRINDING GUIDE

Select the correct metal bond diamonds for your application

The following suggestion cover the basic configurations for metal bonded diamond tools.

Applications	Metal bond	Grit size	Full set - inner and outer row	Full set - outer row	Half set - inner and outer row	Half set - outer row
Flatten floor - Hard concrete	Soft	16 or 30	X			
Flatten floor - Medium concrete	Medium	16 or 30	X			
Flatten floor - Soft concrete	Hard	16 or 30	X			
Ceramic tile adhesive removal	Medium	PIRANHA™ or 16-30	X			
Vinyl or Carpet glue removal - Hard concrete	Soft	PIRANHA™ or 16-30			X	X
Vinyl or Carpet glue removal - Medium concrete	Medium	PIRANHA™ or 16-30			X	X
Vinyl or Carpet glue removal - Soft concrete	Hard	PIRANHA™ or 16-30			X	X
Epoxy paint removal - Hard concrete	Soft	PIRANHA™ or 16-30		X	X	
Epoxy paint removal - Medium concrete	Medium	PIRANHA™ or 16-30		X		
Epoxy paint removal - Soft concrete	Hard	PIRANHA™ or 16-30		X		
Rain damaged concrete	Hard	16-30	X		X	
Smoothen exposed aggregate	Hard	16-30	X		X	
Lippage removal in terrazzo/ stone tiles	Soft	30 or 60	X			
Surface polishing of concrete floors - Hard concrete	Soft	60			X	X
Surface polishing of concrete floors - Medium concrete	Medium	60			X	X
Surface polishing of concrete floors - Soft concrete	Hard	60			X	X
Grinding to exposed aggregate in concrete - Hard concrete	Soft	16-30	X	X	X	
Grinding to exposed aggregate in concrete - Medium concrete	Medium	16-30	X	X	X	
Grinding to exposed aggregate in concrete - Soft concrete	Hard	16-30	X		X	
Flatten undulation in concrete floors - Hard concrete	Soft	16 or 30	X	X	X	
Flatten undulation in concrete floors - Medium concrete	Medium	16 or 30	X		X	
Flatten undulation in concrete floors - Soft concrete	Hard	16 or 30	X		X	

GRINDING GUIDE

Resin bond diamonds

Redi Lock resin attachment adaptor

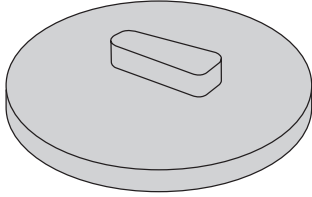

Full set - outer row

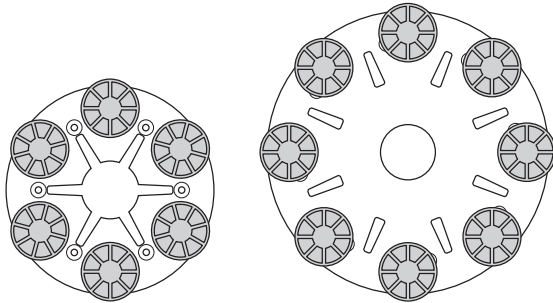

PG 280

PG 400

Half set - outer row

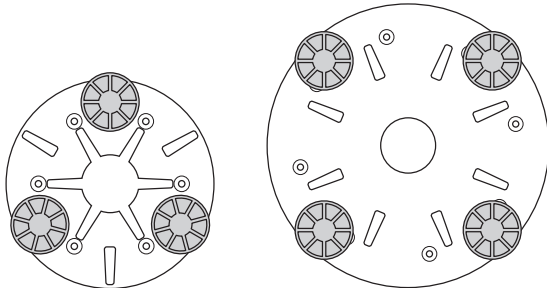

PG 280

PG 400

Selecting the correct resin bond diamond configuration for your application

Applications	Full set - outer row	Half set - outer row
Polishing terrazzo/stone tiles	X	
Resurfacing terrazzo/stone tiles		X
Surface polishing of concrete floors - Hard concrete		X
Surface polishing of concrete floors - Medium concrete		X
Surface polishing of concrete floors - Soft concrete		X

STARTING AND STOPPING

Before starting



- Position grinder on the working area.
- Make sure there are diamonds beneath the machine and that they are firmly attached.
- Adjust the height of the grinding discs with the crank. Make sure that the dust skirt connects closely to the floor.
- Connect the vacuum cleaner to the machine.
- Set handle to most comfortable working height.
- Plug power supply to machine.
- Check that the emergency stop button is not pressed by turning it clockwise.

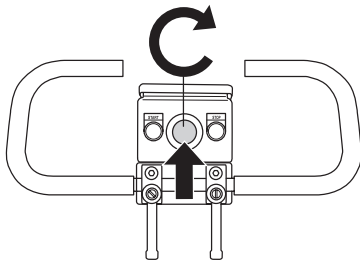

Check the motor's direction of rotation (3 phase)

- Reduce the pressure between grinding disc and floor by pushing down the handle until the disc rises a bit.
- Press the start button and keep it pressed a few seconds to start the machine.
- The fan on the engine body must rotate in the same direction as indicated by the arrow on the cover. If it rotates in the wrong direction, the phase inverter in the plug must be adjusted with a screwdriver before continuing to grind.

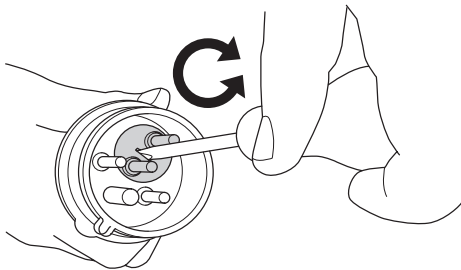

Starting



- Reduce the pressure between grinding disc and floor by pushing down the handle until the disc rises a bit.

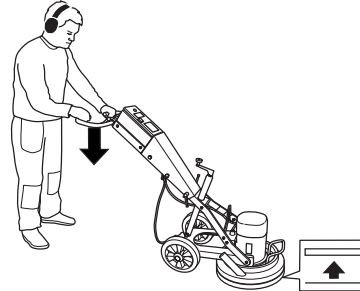

- Press the start button and keep it pressed a few seconds to start the machine.

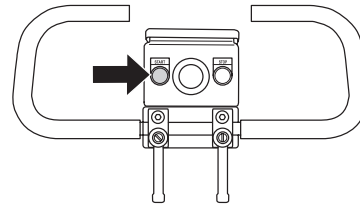

Stopping



- Use the stop button to shut down the machine.

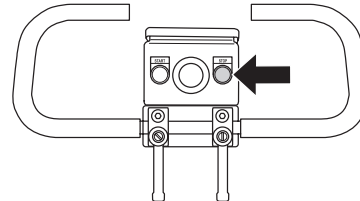

MAINTENANCE

Faults and trouble shooting

The machine will not run

Check the power supply and the power cables and make sure that they are not damaged.

Check that the emergency stop button is not pressed by turning it clockwise.

Machine is hard to hold onto

Not enough diamonds under the machine (if grinding thick glue or soft floors, too few diamonds under the machine will greatly increase the load on grinder and operator). Usually also accompanied by high current draw by motor.

Increase number of diamonds under machine to reduce load on grinder and operator.

Machine is jumping around

Grinding head may be worn-out or damaged. Check grinding head for damage and wear.

Diamonds may not be fitted correctly or have different heights. Check to ensure all diamonds are fitted correctly and are the same height.

The machine stops after just a while

The machine is overloaded and the overload protection has been released. Reduce load. The machine will reboot after about a minute when the motor has cooled off.

The machine stops at start

The electric motor has been overload or a phase is down. This is why the motor cut-out, which is there to protect the electric motor, has tripped. Only an authorized electrician may repair any possible damage.

Maintenance



IMPORTANT! Inspection and/or maintenance should be carried out with the motor switched off and the plug disconnected.

Used correctly, the machine is an extremely low-maintenance and reliable.

Cleaning



Always pull out the plug from the outlet socket before cleaning, maintenance or assembly.

Always clean all the equipment at the end of the working day. Do not use a high pressure washer to clean the machine.

In order for the machine to always be cooled sufficiently the cooling air openings must be kept clear and clean.

Electrical Feed



WARNING! Never use damaged cables. They can cause serious, even fatal, personal injuries.

Check that the cord and extension cord are intact and in good condition.

Never use the machine if the cord is damaged, hand it in to an authorized service workshop for repair.

Skirt

Make sure that the rubber skirt is intact and clean and that it seals tightly against the floor. Damaged rubber skirt should always be replaced.

Service



IMPORTANT! All types of repairs may only be carried out by authorised repairmen. This is so that the operators are not exposed to great risks.

TECHNICAL DATA

Technical data

	PG 400 SF	PG 280 SF	PG 280 SF (Single-phase)
Motor Power, kW/hp	4/5,4	3/4	2,2/3,0
Rated current, A	16	16	12,9
Rated voltage, V	400	400	230
Weight, kg/lbs	115/254	70/154	70/154
Grinding width, mm/inch	400/16	280/11	280/11
Grinding pressure, kg/lbs	65/143	35/77	35/77
Speed, rpm	1400	2800	1400

US WARRANTY STATEMENT

WARRANTY POLICY

All warranty claims will be determined after inspection at a designated facility. A Returned Goods Authorization is required for all warranty claims. Contact Husqvarna Customer Service Department at 800-845-1312 for an RGA. The customer must prepay the freight and absorb any labor expense required to return or replace a product submitted for warranty consideration. Husqvarna will pay return shipping expenses for repaired or approved replacement products.

EQUIPMENT

Equipment manufactured by Husqvarna is warranted to be free from manufacturing defects in normal service for a period of two (2) years from date of purchase by the original consumer purchaser. **Component manufacturers offer separate warranty periods. Call Technical Services at 800-288-5040 for complete information.**

Our obligation under this warranty is expressly limited to the replacement or repair at Husqvarna Construction Products North America, Olathe, Kansas 66061, or at a service facility designated by us, of such part or parts as inspection shall disclose to have been defective.

This warranty does not apply to defects caused by damage, unreasonable use, faulty repairs made by others than an approved Husqvarna servicing dealer, or defects caused by failure to provide reasonable maintenance, while in the possession of the consumer. Further, the warranty is void if the product, or any of its components, are altered or modified by the consumer purchaser, or if the product is used in an inappropriate manner or with tools not recommended by the manufacturer.

Exceptions: Drill motors - 3 months, Wall saws - 1 year, Power cutters - 3 months, DM230 - 1 year, DM225 - 3 months, Gyro systems - 1 year, CD40 system - 1 year, DS160 C - 1 year, Smart box - 1 year, CS2515 - 1 year, PP455 E - 1 year, PP345 E - 1 year, HP40 - 1 year.

Wear items: Filters, spark plugs, bearings*, belts, wheels** and wear pads.

*Except IntelliSeal™ system. **Except delamination.



www.husqvarnacp.com

1151254-95

2008-08-21

